



GloTech Corporation

GEM2 SERIES
Flow Meters

GEM2 Series Electromagnetic Flow Meters

Reliable and Accurate Battery-Powered Mag Meter
for Municipal and Industrial Applications

Proudly Engineered in the USA



*Built-in data logger on meters
manufactured after 01.2025*



GEM Series Flow Meter		CE
Model	GEM	 LISTED 16164877
Nominal Diameter	4"	
Configuration	AI-SS-S	
Power	9-32V DC/AC 1W 3.6V19Ah x 5	
Serial No.	GEM25040001	
Production Date	01.2025	

















An unrivaled combination of performance, dependability, and value

The GEM2 series electromagnetic flow meters utilize cutting-edge technology to deliver reliable and precise measurements of fluids across a wide variety of industries and applications. GEM2 series mag meters feature advanced sensor and transducer designs, which enable maximum flexibility to provide superior accuracy in even the most challenging fluid applications and installation conditions. The advanced measurement technology is combined with a heavy-duty design and GloTech's uncompromising standards on material and manufacturing quality. The result is a meter that offers market leading performance and durability at an unbeatable value.

Applications

-  Groundwater intake
-  Water transfer and distribution
-  Water and wastewater treatment
-  Industrial process control
-  HVAC / cooling water
-  Irrigation and pumping systems

Key Features

-  No moving parts, resulting in low maintenance requirements and minimal head loss
-  Minimal straight pipe requirements
-  Rugged construction rated to IP68
-  Pulse, 4-20mA, and Modbus output standard
-  Convenient built-in data logger
-  Android and iOS Bluetooth app
-  NSF/ANSI 61 certified



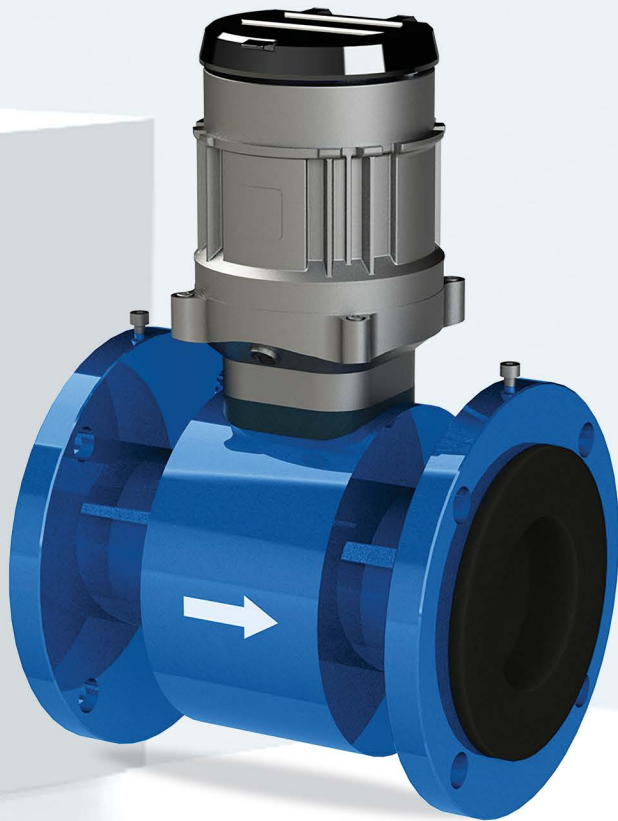

Technical Specifications

Size	2" ~ 80"
Medium Temp	≤140 F (standard) ≤320 F (optional)
Ambient Temp	- 40 F ~ 140 F
Conductivity	≥ 10 uS / cm
Flow Velocity	0.3 ~ 40 ft / s
Accuracy	±0.5 %
Enclosure Rating	IP68
Max Pressure	290 psi (standard)
Flange Standards	ANSI, DIN, BS
Estimated Battery Life	5 years with normal usage
Power	3.6V 19Ah x 5 8 ~ 32V DC / 8 ~ 32V AC
Outputs	Pulse / Frequency, 4-20mA, Modbus®, Sensus® (optional)
Data Logger (Optional)	10-year storage. Convenient data retrieval via Bluetooth
Meter Housing	Carbon Steel
Electronics Housing	Die Cast Aluminum
Flow Tube	304 SS
Liner	Neoprene, PTFE, FEP
Electrodes	316 SS, Titanium, Hastelloy
NSF 61	Rubber liners, 4" and above; PTFE liners, all sizes

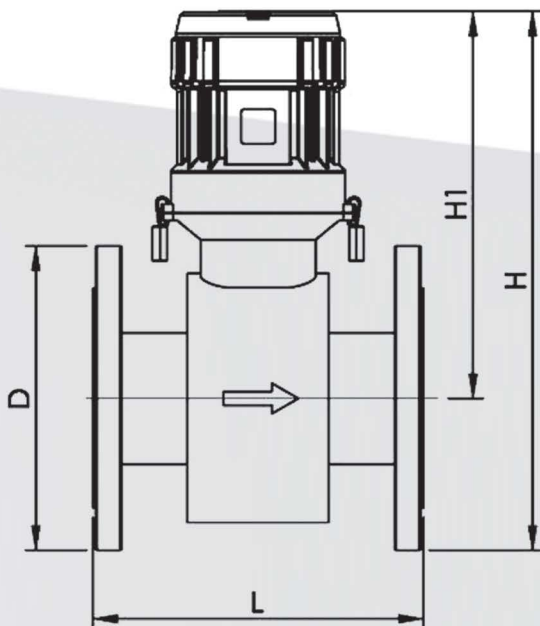

Product Range

SIZE*	L	H	H1	D**	W(lbs)
2"	7.9	13.0	10.0	6.0	29
3"	9.1	14.6	10.8	7.5	41
4"	10.2	15.7	11.2	9.0	51
6"	12.3	17.4	11.9	11.0	68
8"	14.3	19.4	12.6	13.5	108
10"	18.2	21.7	13.7	16.0	157
12"	20.2	24.1	14.6	19.0	223
14"	20.2	25.8	15.3	21.0	287
16"	20.2	28.1	16.3	23.5	342
18"	24.1	29.8	17.3	25.0	397
20"	24.1	32.1	18.3	27.5	463
24"	24.1	35.7	19.7	32.0	573

* Shown in inches. Larger sizes available upon request

**Standard flange dimensions per ANSI 16.5. Other flange standards available



Additional Resources

Please refer to our product website <http://www.glotech-corp.com/products/gem/> to find additional information, download the full IOM manual, and to register/activate your product warranty.

Product Warranty



GEM Android App*



GEM iOS App



Full IOM Manual



*Use password "GEM" to download the Android app
**Phone applications require password "2988" for operation

For general inquiries, contact our product team at: 954.725.8740 / gemsupport@glotech-corp.com

Proudly Distributed By:

